

ARDEN - D

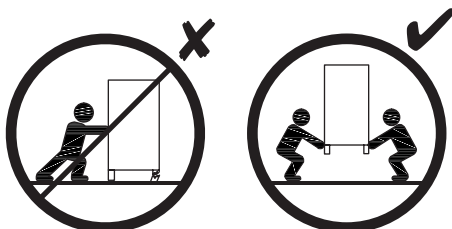

2020-07-16

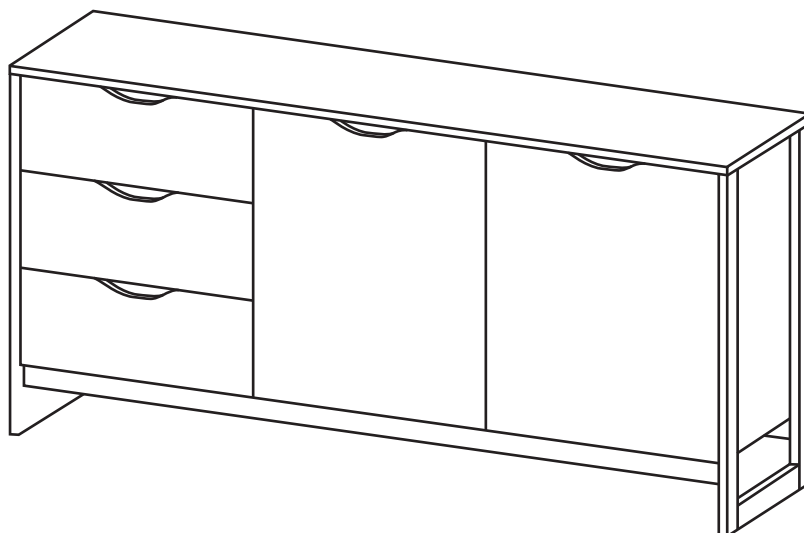

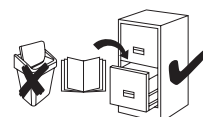
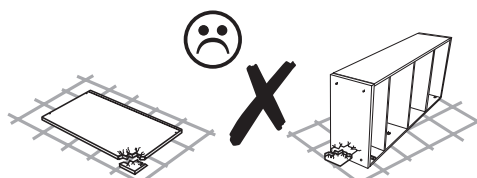
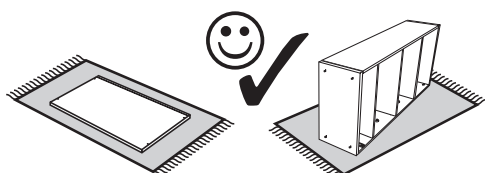
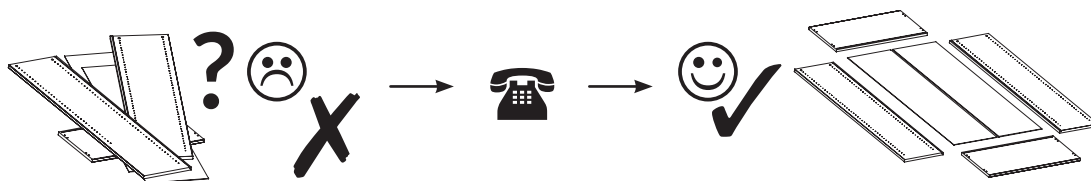
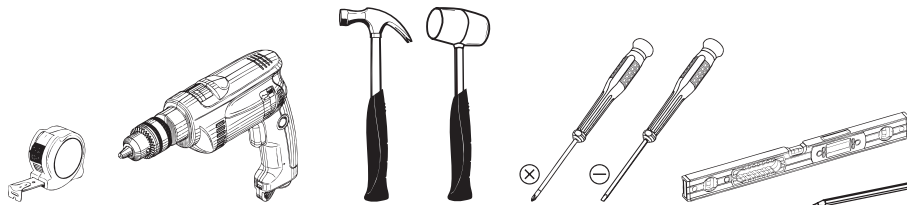
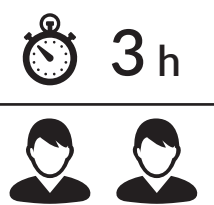
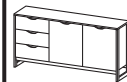

A 7 x 50 mm x 12	B 8 x 32 mm x 36	C (CD) x 2	C3 (B) x 2	DT x 4	E 3,5 x 13 mm x 9
E2 3 x 20 mm x 20	EP2 4 x 20 mm x 30	G2 x 4	H1 x 7	K6 L=350 mm x 3	P x 8
R H=11 mm x 18	RB x 12	T3 5 x 9 mm x 24	T4 6,3 x 24 mm x 8	U L=24,3 mm x 18	W1 x 1
XA x 1	ZA Ø4 x 12	ZR Ø15 x 18			

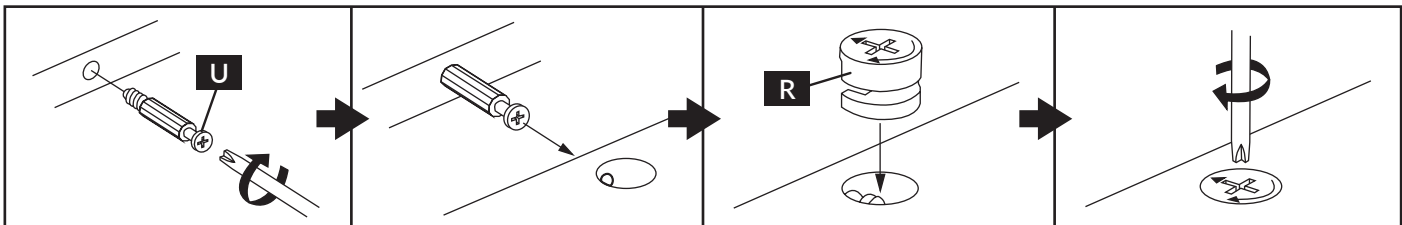
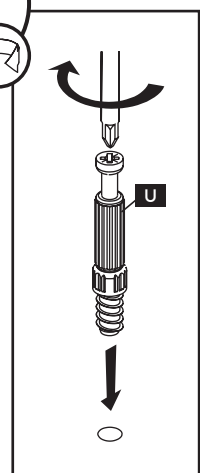
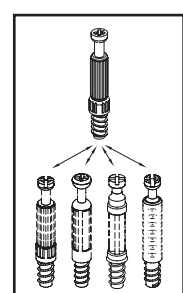
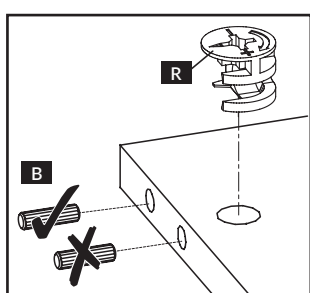
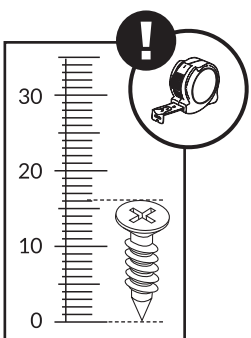
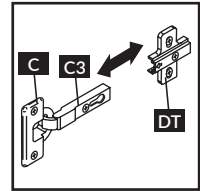
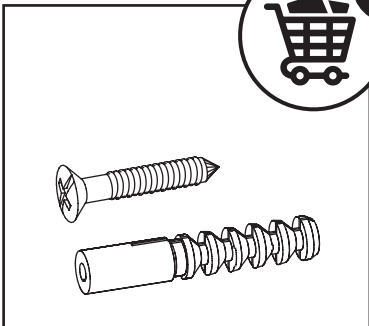

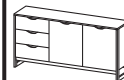

nr	↔ [mm]	↑ [mm]	∅ [mm]	Menge	Colli
D-1	1572	50	15	x2	1/2
D-2	294	50	15	x2	1/2
D-3	766	50	15	x2	1/2
D-4	766	50	15	x2	1/2
D-5	1540	359	16	x1	1/2
D-6	504	340	16	x2	1/2
D-7	1610	396	16	x1	1/2
D-8	616	374	16	x1	2/2
D-9	600	359	16	x1	1/2
D-10	600	359	16	x1	1/2
D-11	616	374	16	x1	1/2
D-12	520	614	16	x1	2/2
D-13	520	614	16	x1	2/2
D-14	1555	622	3	x1	1/2
D-15	520	202	16	x3	2/2
D-16	444	120	16	x3	1/2, 2/2
D-17	350	120	16	x3	1/2
D-18	350	120	16	x3	1/2
D-19	474	356	3	x3	1/2

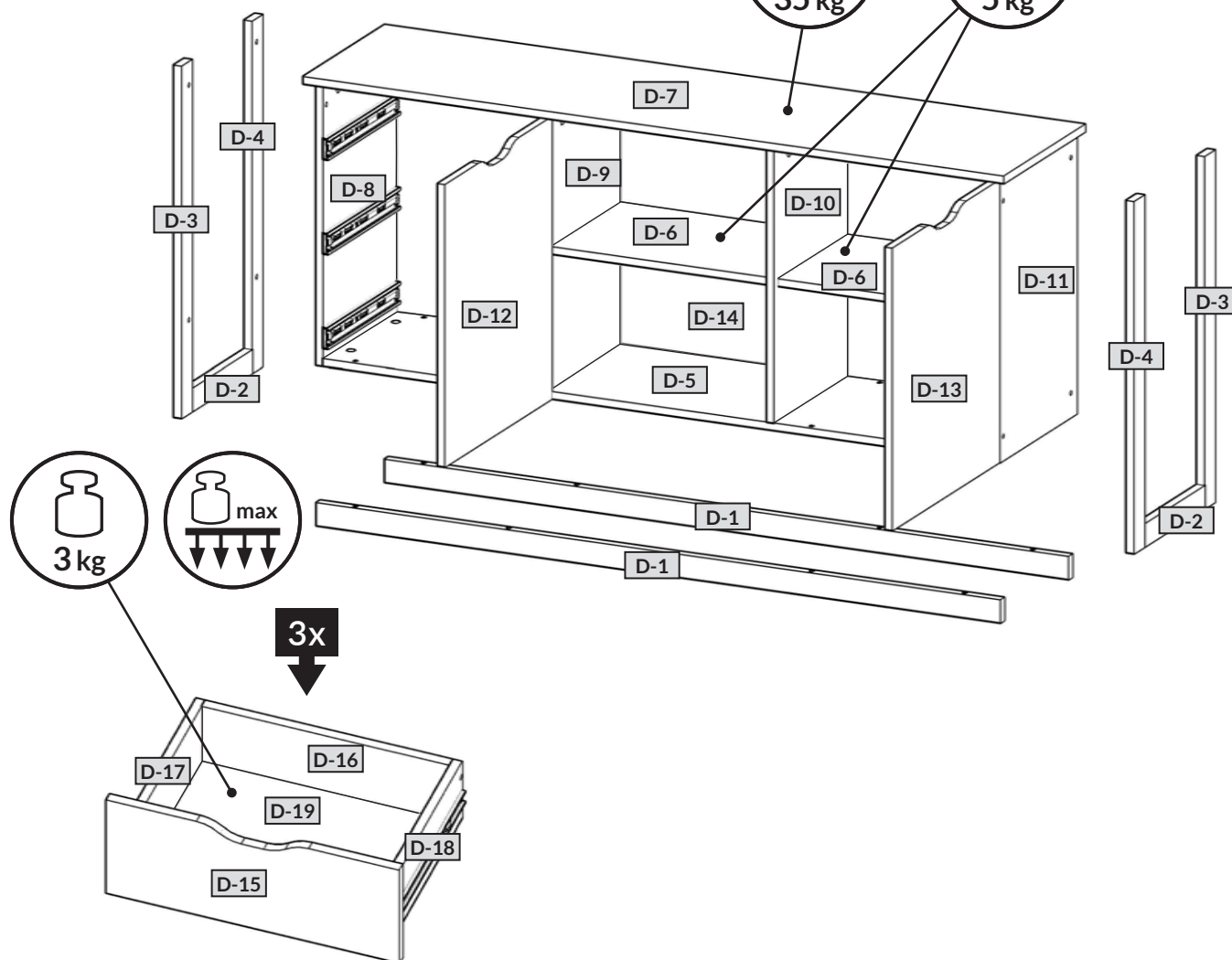
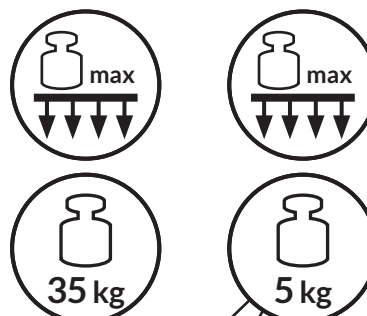

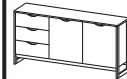

1

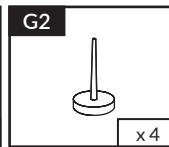
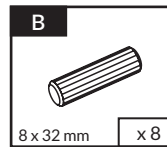
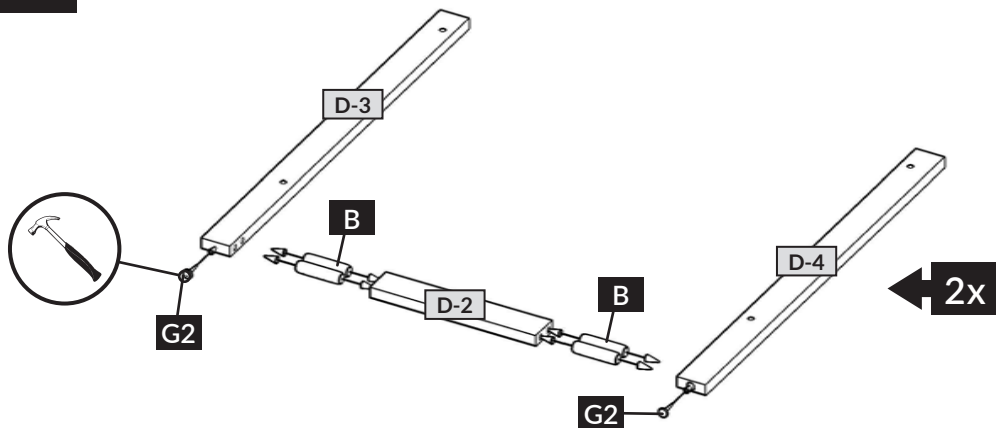

2

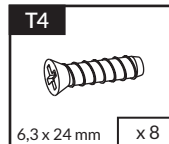
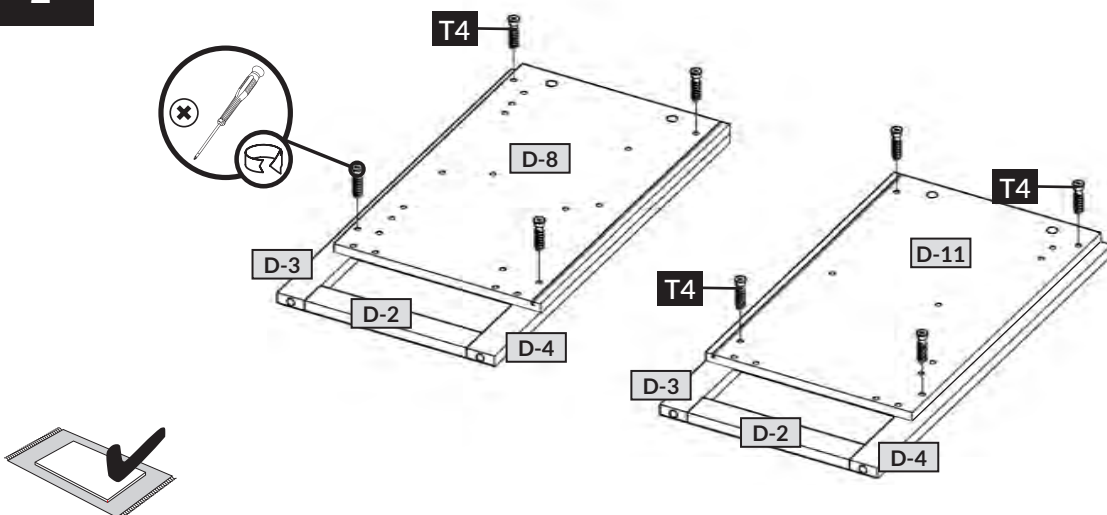

3

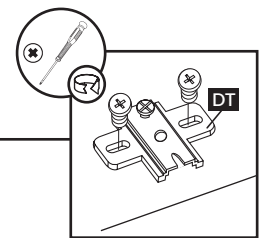
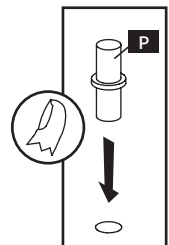
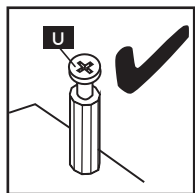
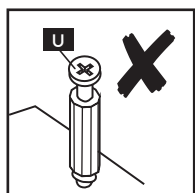
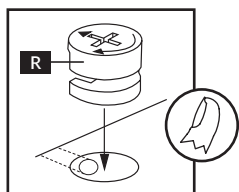
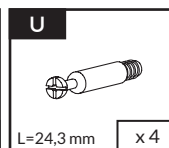
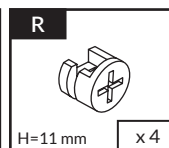
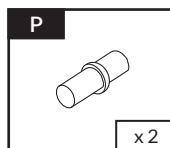
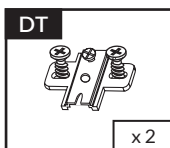
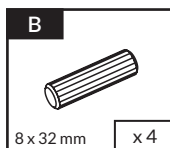
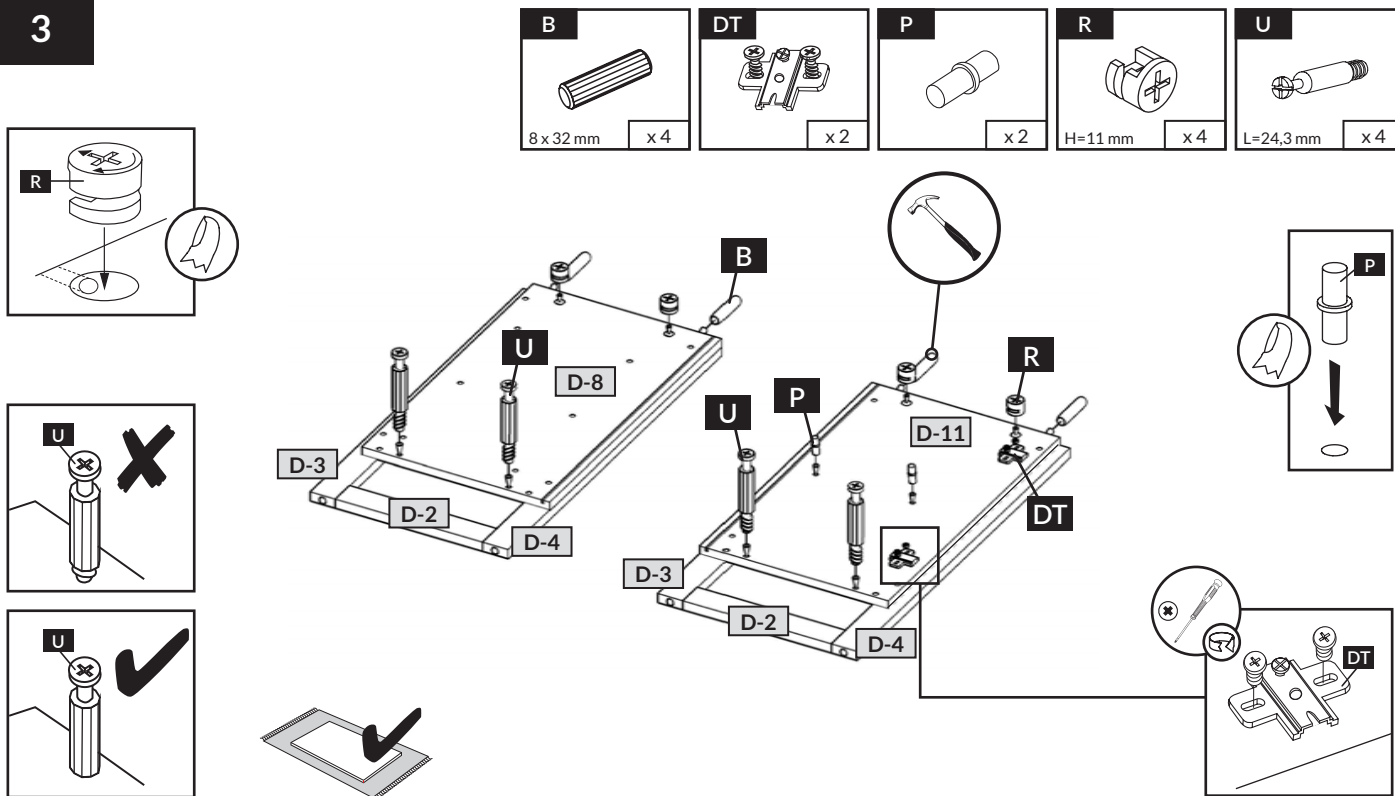

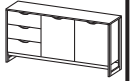

4

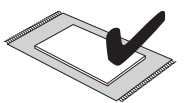
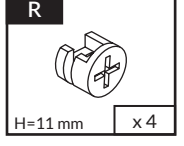
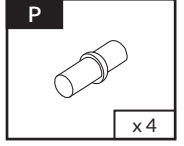
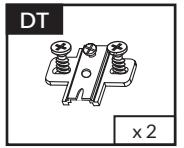
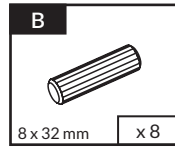
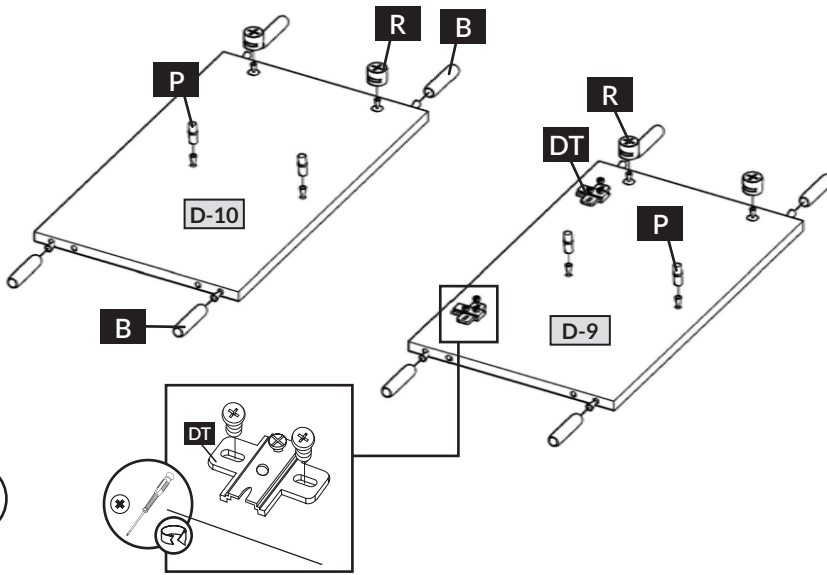
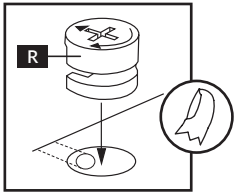
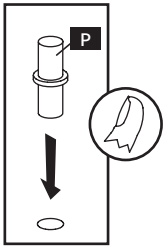

5

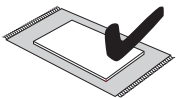
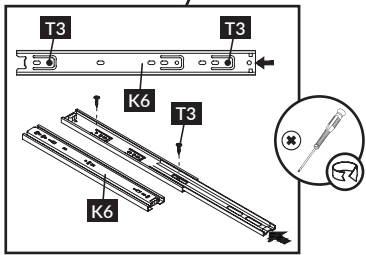
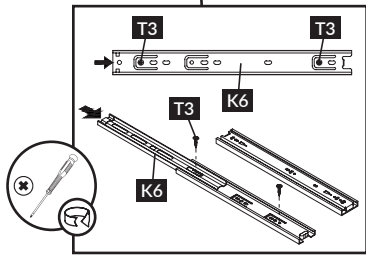
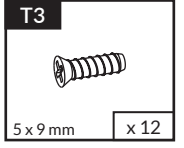
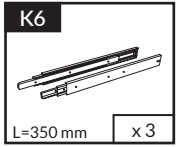
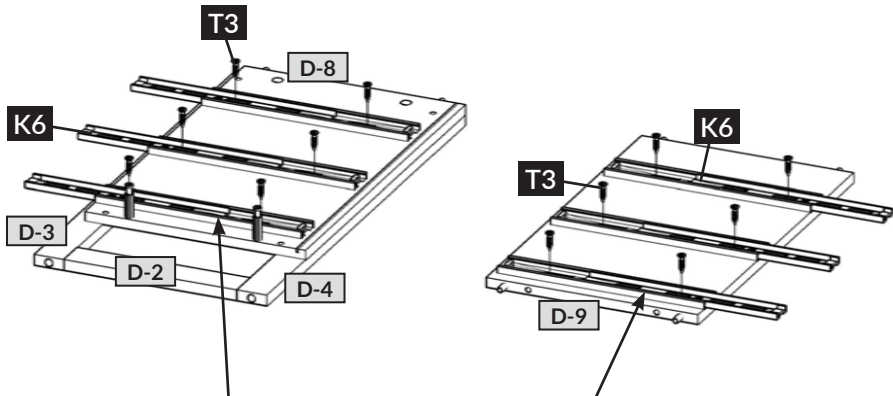
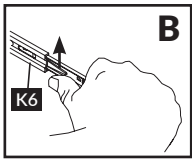
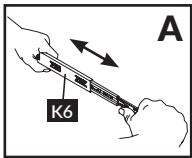

6

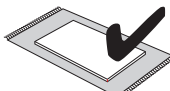
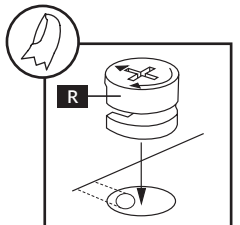
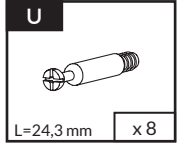
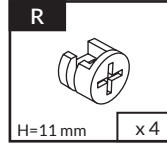
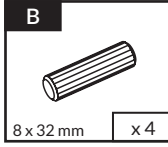
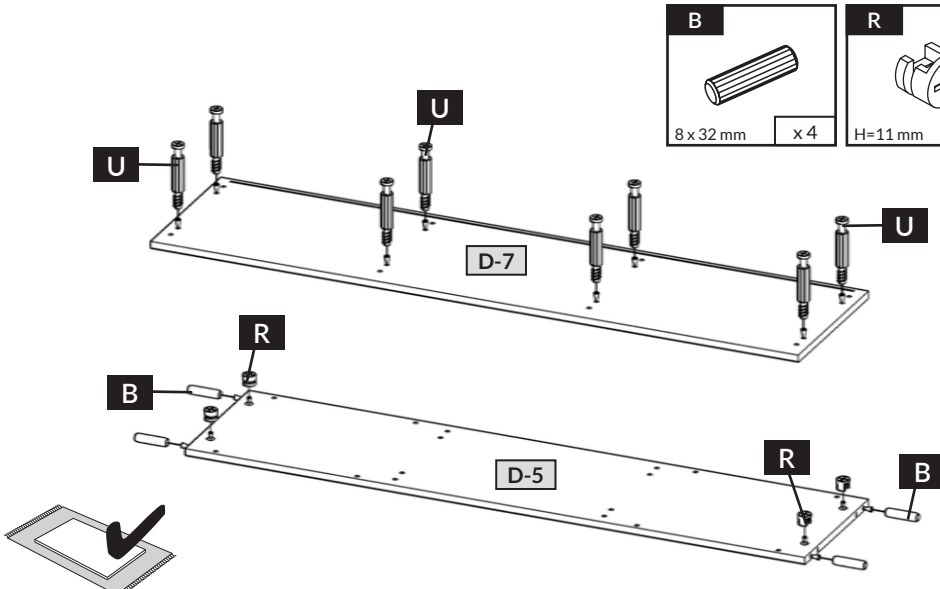
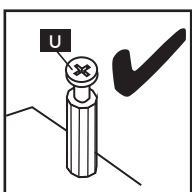
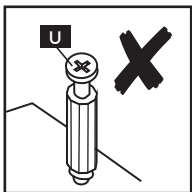

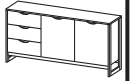

7

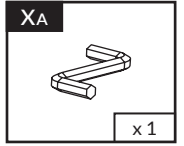
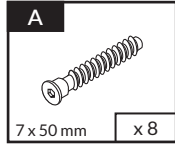
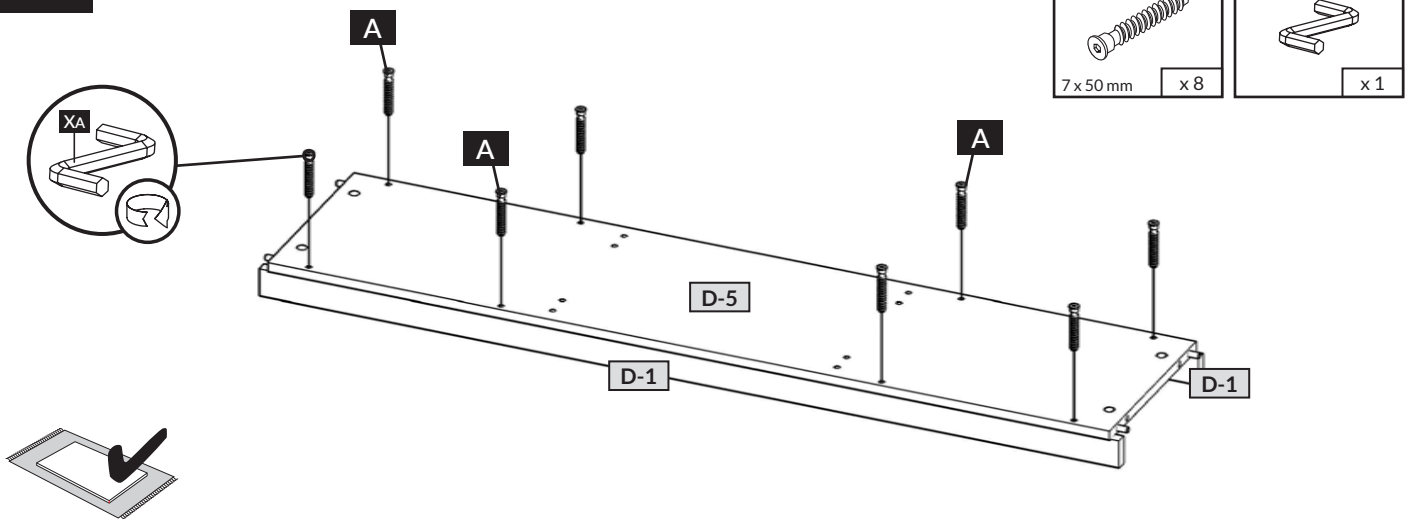

8

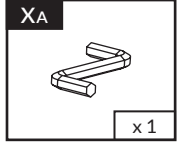
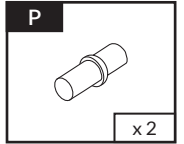
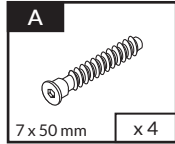
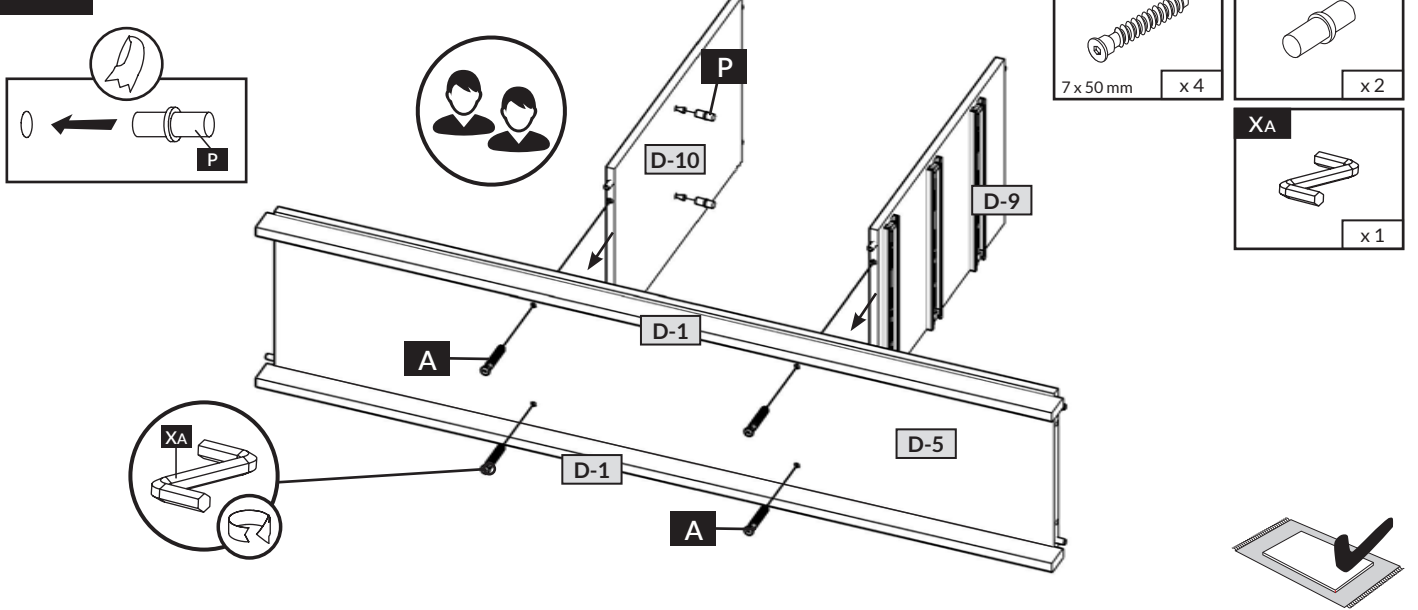

9

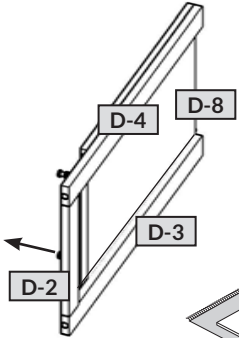
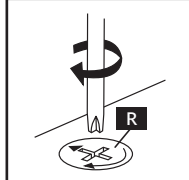
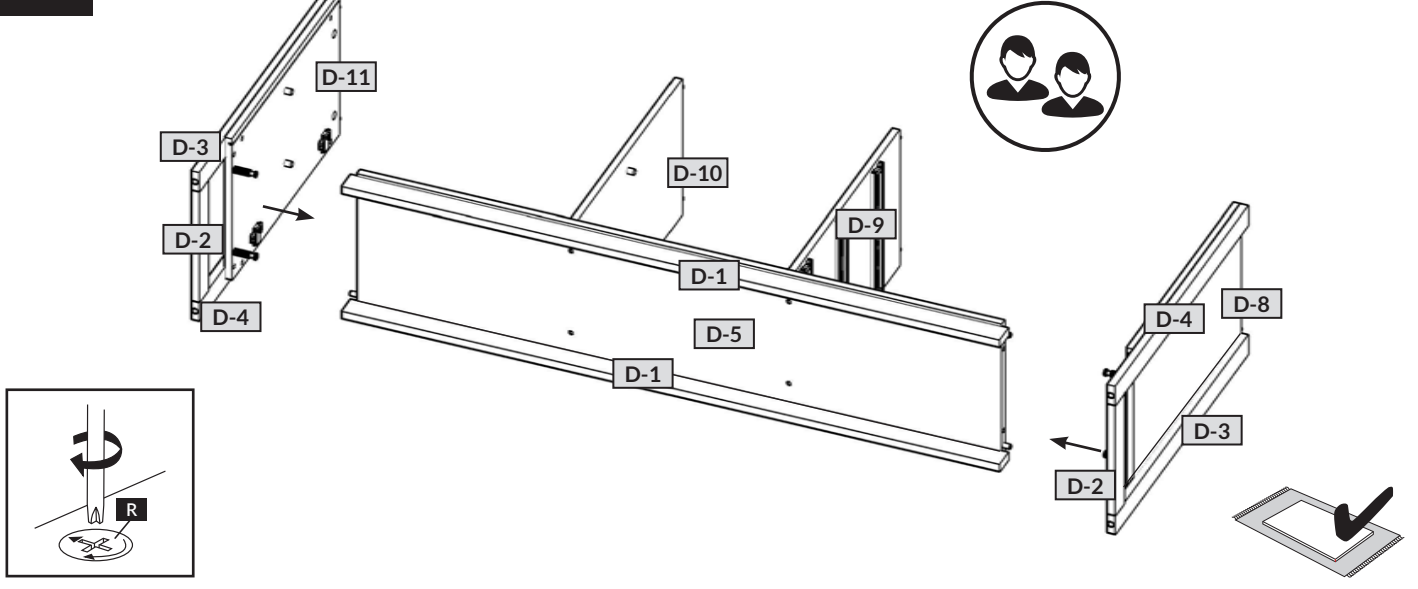

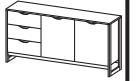

13

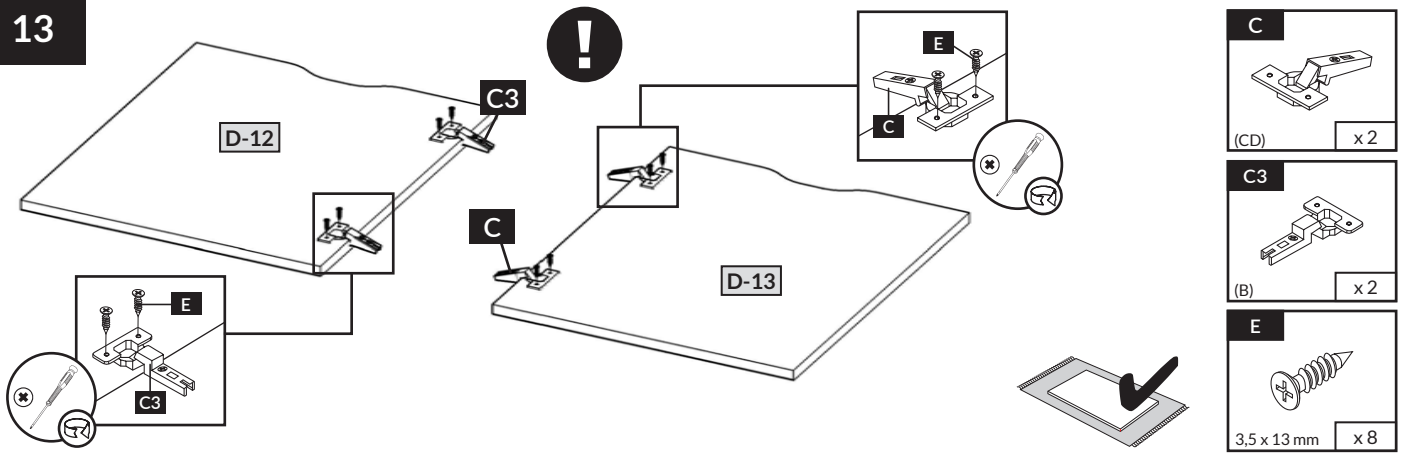

14

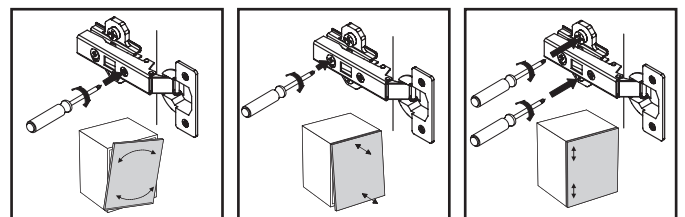
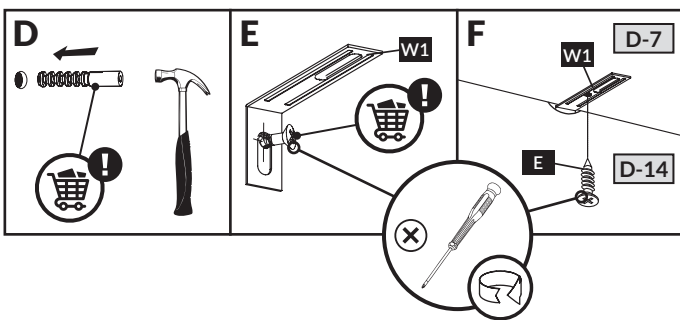
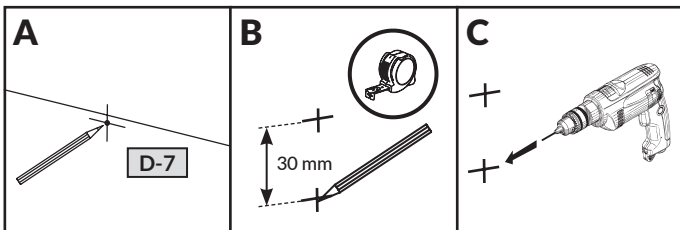
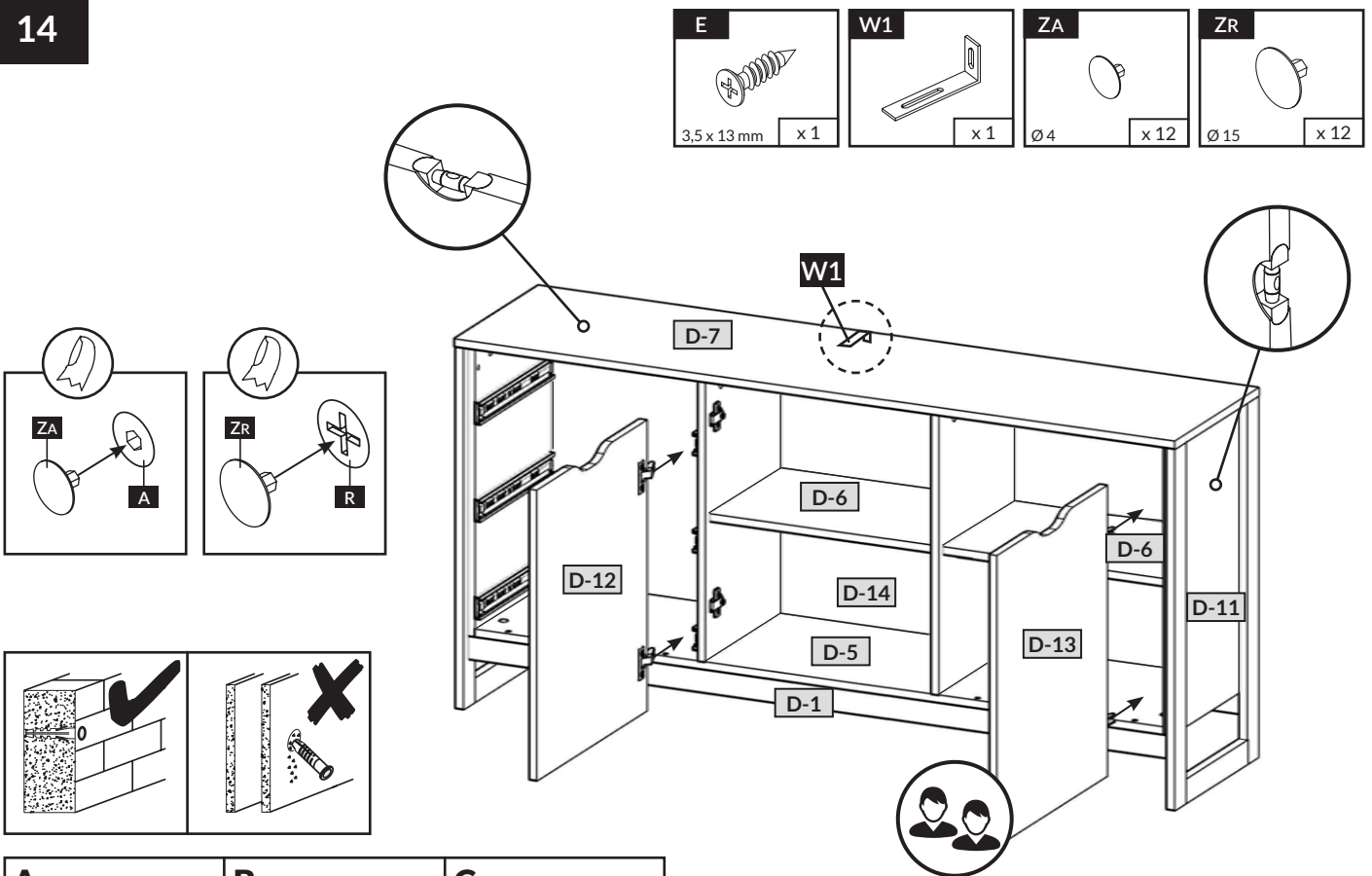

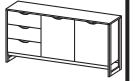

15

3x →

U

D-15

D-17

D-18

R

B

3x

B
8 x 32 mm x 12

R
H=11 mm x 6

U
L=24,3 mm x 6

16

3x ↓

RB

D-17

D-16

D-18

RB

3x

RB
x 12

17

3x →

R

D-15

D-17

D-16

D-18

3x

18

3x →

ZR

R

D-19

D-16

D-18

D-15

3x

ZR
Ø 15 x 6

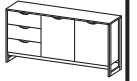

19

3x

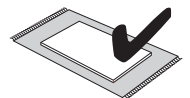
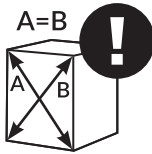
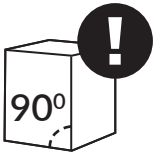
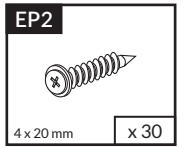
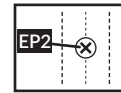
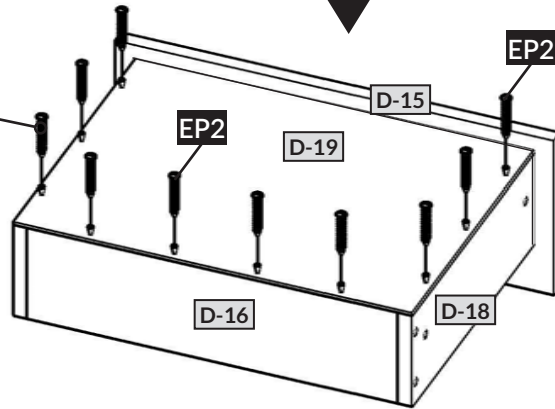

20

3x

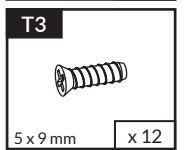
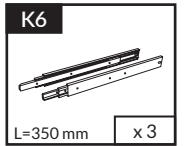
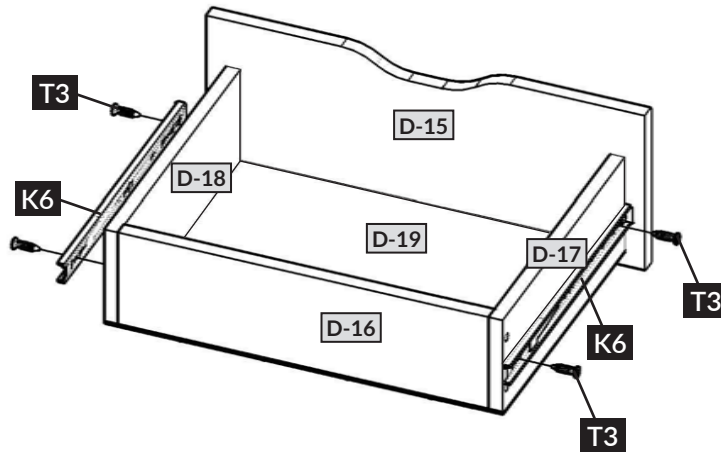

21

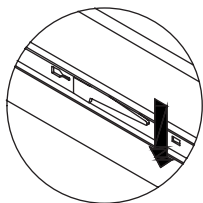
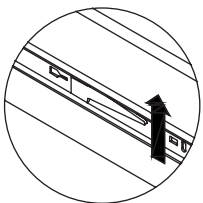

3x

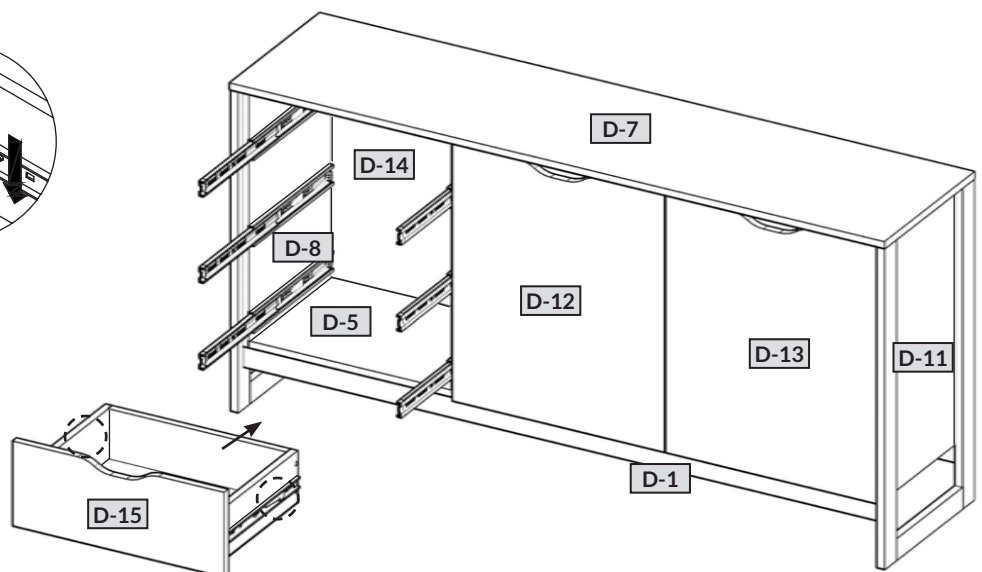

Name • Nom • Nome • Naam • Nazwa • Иméно
• Názov • Név • Denumire • Isim • Извание









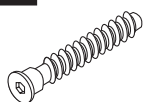
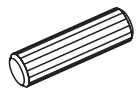
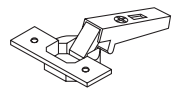
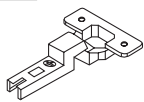
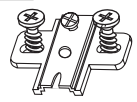
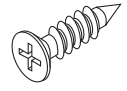

ARDEN

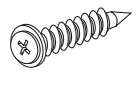
Nr • No • N° • Номер • Č • Sz

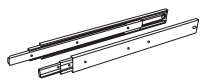
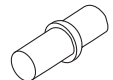
— —

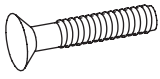
Typ • Type • Tip • Típus • Tipo • Tun

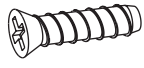
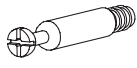
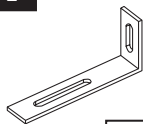
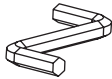
D

<p>A</p>  <p>7 x 50 mm X ...</p>	<p>B</p>  <p>8 x 32 mm X ...</p>	<p>C</p>  <p>(CD) X ...</p>
<p>C3</p>  <p>(B) X ...</p>	<p>DT</p>  <p>X ...</p>	<p>E</p>  <p>3,5 x 13 mm X ...</p>
<p>E2</p>  <p>3 x 20 mm X ...</p>	<p>EP2</p>  <p>4 x 20 mm X ...</p>	<p>G2</p>  <p>X ...</p>
<p>H1</p>  <p>X ...</p>	<p>K6</p>  <p>L=350 mm X ...</p>	<p>P</p>  <p>X ...</p>
<p>R</p>  <p>H=11 mm X ...</p>	<p>RB</p>  <p>X ...</p>	<p>T3</p>  <p>5 x 9 mm X ...</p>
<p>T4</p>  <p>6,3 x 24 mm X ...</p>	<p>U</p>  <p>L=24,3 mm X ...</p>	<p>W1</p>  <p>X ...</p>
<p>XA</p>  <p>X ...</p>	<p>ZA</p>  <p>Ø4 X ...</p>	<p>ZR</p>  <p>Ø15 X ...</p>

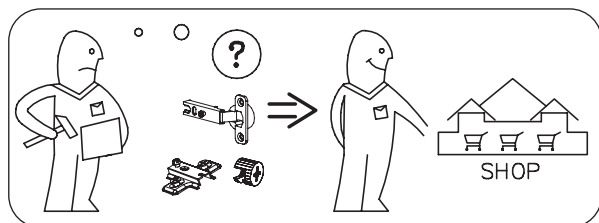
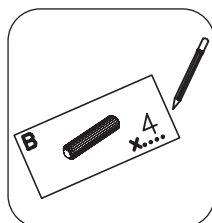

Name • Nom • Nome • Naam • Nazwa • Имя
• Názov • Név • Denumire • Isim • Название

ARDEN

Nr • No • N° • Номер • Č • Sz

--

Typ • Type • Tip • Típus • Tipo • Tun

D

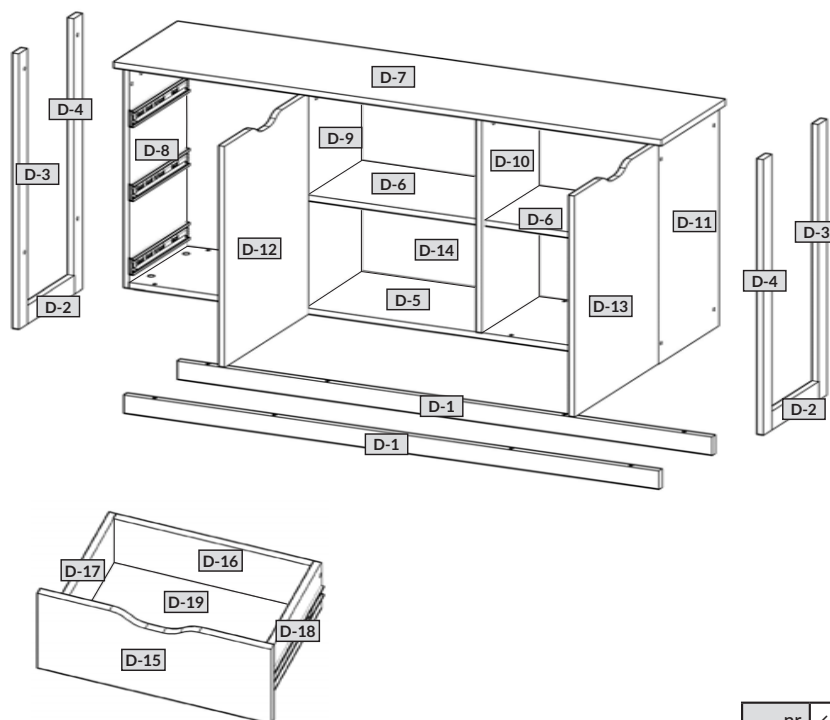

nr	↔ [mm]	↓ [mm]	∅ [mm]	Menge	Colli
D-1	1572	50	15	x 2	1/2
D-2	294	50	15	x 2	1/2
D-3	766	50	15	x 2	1/2
D-4	766	50	15	x 2	1/2
D-5	1540	359	16	x 1	1/2
D-6	504	340	16	x 2	1/2
D-7	1610	396	16	x 1	1/2
D-8	616	374	16	x 1	2/2
D-9	600	359	16	x 1	1/2
D-10	600	359	16	x 1	1/2
D-11	616	374	16	x 1	1/2
D-12	520	614	16	x 1	2/2
D-13	520	614	16	x 1	2/2
D-14	1555	622	3	x 1	1/2
D-15	520	202	16	x 3	2/2
D-16	444	120	16	x 3	1/2, 2/2
D-17	350	120	16	x 3	1/2
D-18	350	120	16	x 3	1/2
D-19	474	356	3	x 3	1/2

